



## 30" Warming Drawer

The superior air control of the Wolf warming drawer helps keep moist foods moist and crisp foods crisp. Stainless steel drawer fronts match the look of our built-in ovens and ranges, and the integrated drawer front allows for a custom wood panel. Electronic controls are hidden so the unit integrates with surrounding cabinetry.



Model WWD30 shown with L series drawer front.

### FEATURES

- Can be installed in a standard or flush inset application.
- UL approved for warming towels.
- Crafted of heavy-duty stainless steel.
- Hidden electronic touch controls for sleek appearance.
- Temperature control range of 80°F to 200°F.
- Four preset temperatures: high 200°F, medium 160°F, low 120°F and proof 85°F.
- Programmable automatic shutoff up to four hours.
- Fan assist for even heat distribution.
- Fast preheat times.
- Rack for stacking food.
- Three ball-bearing drawer glides for smooth, full extension.
- Removable stainless steel drawer for easy cleaning.

### DRAWER FRONT OPTIONS

DRAWER FRONT OPTIONS	HANDLE
L Series	Tubular
E Series Framed and Unframed	Tubular
E Series 1" and 2" Thick	Pro
E Series 2" Thick /36" Wide	Pro
Integrated	Custom

Model WWD30 is sold as a base unit only. A drawer front panel is required. Panels are available through your authorized Wolf dealer. Stainless steel drawer front panels include a handle to match built-in ovens and ranges. Integrated drawer front allows for a custom wood panel and handle hardware.

### ACCESSORIES

- Stainless steel drawer fronts to match style of Wolf ovens and ranges.
- 2" thick stainless steel drawer fronts for installation below sealed burner rangetop.
- Integrated drawer front for custom wood applications—panel can exceed 30" width.
- Six-piece container set with lids.
- Stainless steel tubular and pro handles.

Accessories are available through your authorized Wolf dealer. For local dealer information, visit the find a showroom section of our website, [wolfappliance.com](http://wolfappliance.com).

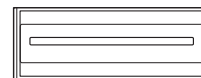

L Series Drawer Front



E Series Drawer Front with Tubular Handle

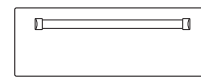

E Series Drawer Front with Pro Handle

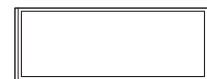

Integrated Drawer Front

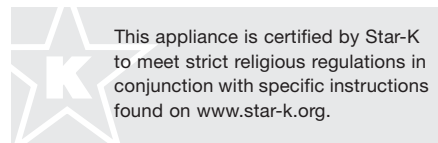

This appliance is certified by Star-K to meet strict religious regulations in conjunction with specific instructions found on [www.star-k.org](http://www.star-k.org).



Accessory container set.



## 30" Warming Drawer

### OVERALL DIMENSIONS

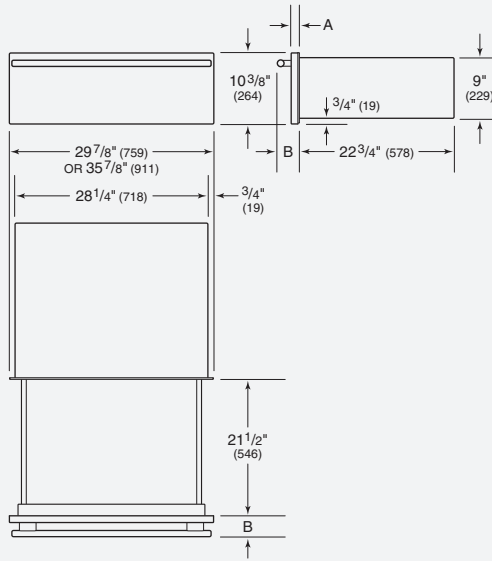

### STAINLESS STEEL DRAWER FRONT

L SERIES	A	B
Tubular Handle	7/8"	3 1/2"

E SERIES	A	B
Tubular Handle	1 1/8"	3 1/2"
Pro Handle	1 1/8"	3 1/2"
Pro Handle (2" thick)	2 1/8"	4 1/2"

### INTEGRATED DRAWER FRONT

CUSTOM PANEL	W	H	D
Typical	29 7/8"	10 3/8"	3/4"

Dimensions may vary by  $\pm 1/8"$ .

### SPECIFICATIONS

Interior Capacity	1.6 cu ft
Interior Dimensions	25" W x 6" H x 18" D
Integrated Panel Thickness (min)	5/8"
Integrated Panel Weight (max)	25 lbs
Heating Element	850 W
Electrical Requirements	120 V AC, 60 Hz 15 or 20 amp circuit
Power Cord	3' cord with grounded plug
Shipping Weight	100 lbs

### INSTALLATION SPECIFICATIONS

#### Standard Installation – L Series, E Series and Integrated Drawer Front

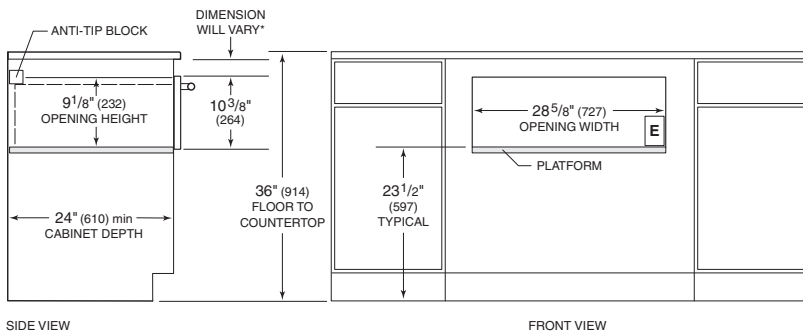

\*Dimension must accommodate height of anti-tip block and drawer face overlap.

NOTE: Location of electrical supply within opening may require additional cabinet depth. Dashed line represents profile of unit.

#### Flush Inset Installation – E Series and Integrated Drawer Front

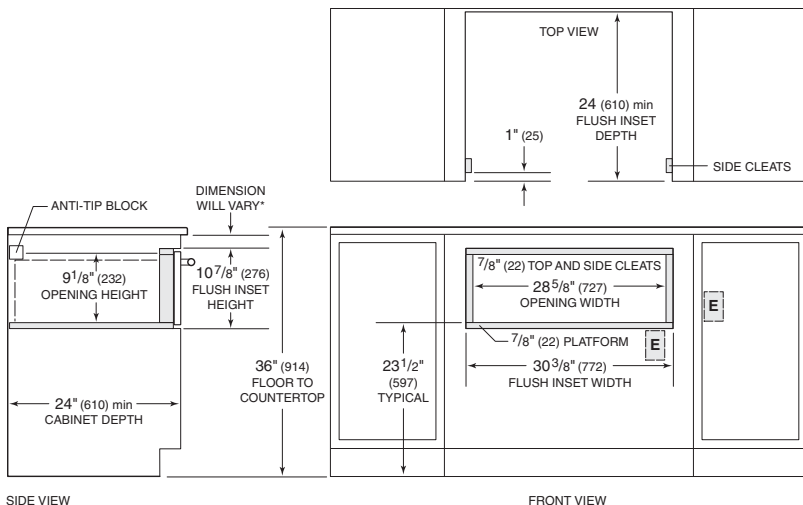

\*Dimension must accommodate height of anti-tip block and drawer face overlap.

NOTE: Dimensions provided allow for 1/4" (6) reveal for proper air flow. Location of electrical supply within opening may require additional cabinet depth. Dashed line represents profile of unit.

Dimensions in parentheses are in millimeters unless otherwise specified.